

World Headquarters



Millar, Inc.
6001-A Gulf Freeway
Houston, Texas 77023-5425 USA
Phone: 832-667-7000 or 800-669-2343 (in the USA)
Fax: 713-714-8497
Email: info@millar.com
Web site: millar.com

Millar Worldwide Distribution

Millar, Inc. has a network of Authorized Distributors in most countries around the world. For information on the Millar distributor in your country, please contact the Millar Customer Service Department at our headquarters in Houston, Texas.



Making the
improbable possible.

Mikro-Tip® Catheter Pressure Transducer

Animal Research Use Only

Model SPR-721

Instructions for Use

© 2007, 2014 Millar, Inc. All rights reserved.
Millar and Mikro-Tip are registered trademarks of Millar, Inc.
Products and company names used are the trademarks or trade names of their respective companies.
Models referred to herein are protected by USA and International patents.

M.I. P/N: 004-2185 Rev. A

Service Provision

Consult web site below for service information:

www.millar.com

Millar Limited Warranty

Millar, Inc. (Millar) warrants that at the time of sale to the original purchaser, the transducer catheter was free from defects in both materials and workmanship. For a period of 365 days (1-year) from the date of original shipment to the original purchaser, Millar will, at no charge and at its option, either repair or replace any Mikro-Tip transducer found to have been shipped with defects in either materials or workmanship. Our warranty does not cover damage to the product from alterations, misuse, abuse, negligence, or accident. The SPR-524 is warranted for a period of 30 days from the date of original shipment to the original purchaser. The SPR-524 is non-repairable.

Millar hereby excludes all warranties not herein stated, whether express or implied by operation of law or course of dealing or trade usage or otherwise, including but not limited to any implied warranties of fitness or merchantability.

Since handling, storage, cleaning and sterilization of the product, as well as factors relating to research subject diagnosis, treatment, catheterization procedures, and other matters beyond Millar's control, directly affect the product and the results obtained from its use, Millar shall not be liable for any incidental or consequential loss, damage, or expense arising directly or indirectly from the use of this product.

The user shall determine suitability for use of these transducer catheters for any animal surgical research or physiological evaluation procedure. Therefore, the user accepts these transducer catheters subject to all the terms hereof. Further, Millar makes no warranty regarding transducer catheter efficacy after three (3) years from the date of manufacture.

Table of Contents

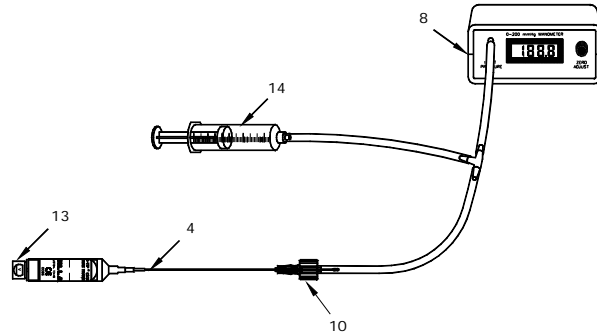









Figure 3b

Item #	Description		Item #	Description
1.	Pressure Sensing Area		8.	Manometer
2.	Wires to Connector		9.	Tee Fitting
3.	Vent to Connector		10.	Plastic Dome
4.	Catheter		11.	Pressure Transducer
5.	Silicone Rubber Diaphragm		12.	To Recorder
6.	Pressure Sensor		13.	Connector
7.	Adapter		14.	Syringe

RECOMMENDED ACCESSORIES	1
TRANSDUCER CATHETER DESCRIPTION	1
INTENDED USE/INDICATIONS	2
WARNINGS	2
PRECAUTIONS	2
MAINTAINING TRANSDUCER CATHETER EFFECTIVENESS	2
STORAGE	2
PLASTIC DOME FITTING	3
ROUTINE INSPECTION AND TESTING	3
CATHETER	3
PRESSURE SENSOR(S)	3
CONNECTOR(S) AND CABLE(S)	3
TRANSDUCER VERIFICATION AND SETUP	3
OPERATING INSTRUCTIONS	3
OPERATIONAL NOTES	4
PHONOCARDIOGRAM RECORDING	4
HANDLING PRECAUTIONS FOR MIKRO-TIP CATHETERS	4
TROUBLESHOOTING AND CORRECTIVE MAINTENANCE	5
CLEANING	5
APPROVED CLEANERS AND DISINFECTANTS	5
WATER RESISTANT CONNECTOR CAPS	6
CLEANING PROCEDURE	6
DISINFECTION	6
RINSING AFTER DISINFECTION	6
METHOD OF STERILIZATION FOR CATHETERS AND EXTENSION CABLES (OPTIONAL)	7
ETHYLENE OXIDE STERILIZATION CYCLE PARAMETERS	7
SENSOR SPECIFICATIONS	8
SCHEMATICS	9
FIGURES	10
SERVICE PROVISION	12
MILLAR LIMITED WARRANTY	12

Recommended Accessories

M.I. P/N: 851-5918, Model TC-510 Control Unit, No patient isolation
 M.I. P/N: 880-0129, Model PCU-2000 Control Unit with Patient Isolation
 M.I. P/N: 850-1118, Model TEC-5C Extension Cable
 M.I. P/N: 850-1108, Model TEC-10C Extension Cable
 M.I. P/N: 850-1308, Model TEC-10D Extension Cable
 M.I. P/N: 850-5088, Model PEC-1.5C Extension Cable to PCU-2000
 M.I. P/N: 850-5089, Model PEC-10C Extension Cable to PCU-2000
 M.I. P/N: 850-5103, PEC-4D Extension Cable to PCU-2000
 M.I. P/N: 850-5090, PEC-10D Extension Cable to PCU-2000
 Monitor Input Cables as appropriate for monitor.
All accessories sold separately.

Definition of Symbols	
	Attention, consult accompanying documents
	Date of Manufacture
REF	Catalog Number
SN	Serial Number
	Batch Code
	Use By Date
	Electrostatic Sensitive Device
	EU Declaration of Conformity
	Manufacturer Symbol

Transducer Catheter Description

Mikro-Tip catheters consist of an ultra-miniature pressure sensor(s) at the distal end of a catheter, as shown in Figure 1, with an electrical connector(s) at the proximal end. The pressure sensor produces an electrical output signal, which varies in direct proportion to the magnitude of sensed pressure.

Mikro-Tip catheters are intended for multiple uses. Experience has proven that the instruments are safe and effective for extended service if proper handling, cleaning, and sterilization procedures are followed.

Immediately upon receipt of the catheter, and prior to its initial cleaning, sterilization, and use, the customer should verify that the catheter is operational.

Flexible extension cables are available for connection between the pressure connector and the pressure control unit. These flexible cables facilitate maneuvering the catheter during recording. They may be sterilized to permit connection of the transducer to a Millar control unit outside the sterile field.

Figures

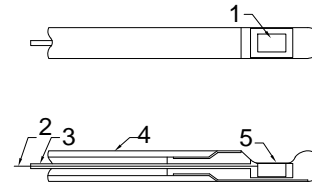

Figure 1

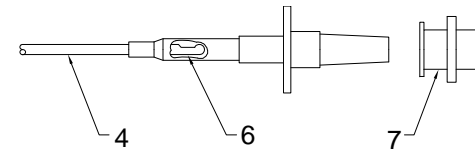

Figure 2

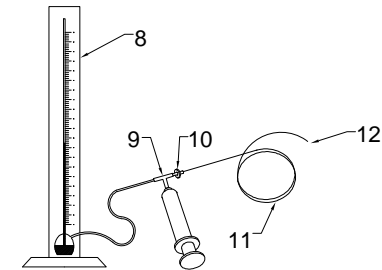
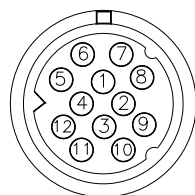
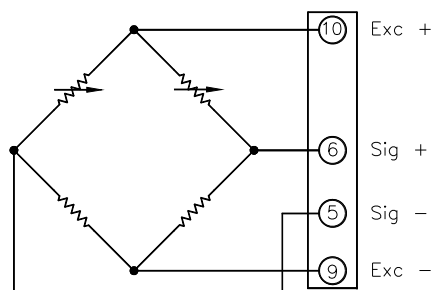

Figure 3a

Schematics



Sensor & Viking Connector

Intended Use/Indications

The use of Mikro-Tip catheter is indicated when physiological pressures are to be measured.

For cardiovascular applications, Mikro-Tip catheters may be introduced into the cardiovascular system percutaneously or through the wall of a surgically exposed artery or vein.

With the aid of fluoroscopy or echocardiography, the transducer may be advanced from the introduction site to the desired location.

This product is designed for use by professionals with appropriate education and training in life science and medical research applications.

Warnings

- Mikro-Tip transducer catheters are shipped with a plastic or foam dome fitting over the pressure sensor. The dome should be in place during handling.
- Do not allow any body fluids to collect under protective covering on catheter connector; otherwise, sterilization cannot be assured.
- Risk of infection may result if transducer catheter is not discarded using proper procedures relating to Biological Hazards.
- No modification of this equipment is allowed.
- DO NOT use the Mikro-Tip catheter in close proximity to high electrical noise-generating equipment, as this may cause interference with the signal.

Precautions

Use of Mikro-Tip catheters should be restricted to specialists who are familiar with, and have been trained to perform, the catheterization procedures for which the transducer catheter is intended.

- Inspect the Mikro-Tip catheter for damage (cracking, kinks, etc.) prior to each use.
- Always make sure before insertion that the catheter is perfectly straight from the sensor tip back to one inch from the tip. The presence of bends that do not straighten out in this area are an indication the catheter has been damaged and should not be used.
- Clean the Mikro-Tip catheter immediately after each use (see Cleaning).
- Store Mikro-Tip catheters in a dark, cool, dry place.
- Do not touch the sensor area with sharp objects. Do not make sharp bends in the catheter.
- The catheter may be damaged if the sensor tip is subjected to a pulling force greater than one pound. Do not apply excessive pulling force to the catheter.
- Refrain from applying direct pressure to the sensor area with instruments such as forceps or tweezers.
- When handling the catheter with either fingertips or surgical instruments, always grip several millimeters (5-10 mm) proximal to the sensor area. The sensor area contains very fragile wires which may be damaged or broken if the catheter is gripped too close to the sensor.
- Avoid electrostatic discharge to the Mikro-Tip sensor. Do not touch the sensor element while the catheter is disconnected from monitoring equipment.
- See package labeling information for expiration date allowing for safe use of the Mikro-Tip catheter.

Maintaining Transducer Catheter Effectiveness

Storage

Store the catheter in the plastic tray provided. Make sure the catheter has a plastic or foam dome fitting over each pressure sensor.

Plastic Dome Fitting

All catheters are shipped with a protective tubing(s) and/or plastic dome fitting over the pressure sensor(s) to protect the sensor from damage. Plastic Domes **ARE NOT** interchangeable.

When using the plastic dome fitting, the tip of the pressure sensor should be positioned inside the plastic dome fitting as shown in Figure 2.

Routine Inspection and Testing

CAUTION: If damage is found during inspection, DO NOT use the catheter. Contact Millar Instruments or authorized distributor.

Catheter

Inspect each catheter thoroughly before and after each use. Carefully examine the catheter for defects.

Pressure Sensor(s)

Examine the pressure sensor active surface (diaphragm) for blood or materials not removed by cleaning. A dirty sensor may cause short-term baseline drift. Follow cleaning directions in this IFU.

Connector(s) and Cable(s)

The connector(s) should be routinely inspected for corrosion or bad contacts. Liquid entering the connector(s) can cause electrical hazard, erratic operation and components corrosion.

Transducer Verification and Setup

CAUTION: DO NOT handle or squeeze the pressure sensor area of the catheter during catheter manipulation!

Each transducer is calibrated for a standardized sensitivity of **5 μ V/V/mmHg (37.6 μ V/V/kPa).**

To verify system outputs, apply a reference pressure signal to adjust sensitivity or to specific monitor requirement. Use a mercury manometer or pressure reference transducer catheter, as shown in Figure 3a or 3b.

Apply a known pressure to the Millar catheter and verify the signal at the monitor.

Follow the instructions for the Millar pressure control unit being used. Set up the mercury manometer as shown in 3a or 3b and compare the 100 mmHg (13.3 kPa) output produced using the mercury manometer with the electrical 100 mmHg (13.3 kPa) produced by the control unit.

Reading errors at or near the 0 mmHg (0kPa) manometer indication can be minimized by offsetting the manometer zero indication to 20 mmHg (26.6 kPa) and using the 100 mmHg (133 kPa) increments from the 20-120 mmHg (26.6 – 160 kPa) pressure indication rather than the 0-100 mmHg (0-133 kPa) pressure indication.

Errors due to inconsistent meniscus shape between consecutive readings can be minimized by adjusting the pressure at each reading to maintain a consistent curve at the top of the meniscus. These errors may be avoided by using an electronic pressure meter as shown in Figure 3b.

Operating Instructions

When Using a Millar Pressure Control Unit (see Control Unit's IFU)

1. Soak the pressure sensor area of the catheter in room-temperature sterile water or sterile saline for 30 minutes prior to use to minimize drift. Do not expose the connector section of the catheter to the water.

Sensor Specifications

	2F Catheter
Type of Sensor	Diffused Semiconductor, piezoresistive
Pressure Range	-50 to + 300 mmHg (-6.7 to 40 kPa)
Overpressure	+4000 mmHg (+530 kPa), -760 mmHg (100 kPa)
Rated Excitation*	2.5-7.5 V _{DC} or V _{AC} rms
Sensitivity	5 μ V/V/mmHg, nominal (37.6 μ V/V/kPa)
Temperature Error Band at Zero Pressure	\pm 3 mmHg (\pm 0.4 kPa) BSL, 23 - 38 °C
Linearity and	\pm 1%, BSL of full scale
Drift**	<6 mmHg (0.8 kPa) in 12 hours
Natural Frequency	\geq 10 kHz
Bridge Resistance	1000 ohms, nominal
Reference Pressure	Atmosphere
Electrical Leakage	< 10 μ A at 180 V _{DC} 10 μ A at 120 V _{AC}
Zero Offset	< \pm 50 mmHg (\pm 6.7 kPa)

* Performance specifications are for 5 V_{DC}. Transient voltages up to 20 volts will not damage the transducer.

** Based on 30 minute presoak.

Method of Sterilization for Catheters and Extension Cables (Optional)

CAUTION: DO NOT sterilize by autoclaving, radiation (gamma or e-beam), plasma, peroxide or formaldehyde vapor solutions.

Catheters must be completely cleaned and dried before sterilization. Aerate at room temperature or in a heated aeration cabinet. (max. 145 °F, 63 °C) Catheters may be sterilized in the white plastic shipping tray. The foam dome and connector caps must be removed and placed alongside the catheter inside the pouch during sterilization. The caps should be saved and reused each time the catheter is cleaned. The tray, with lid, should be placed in a breathable polyethylene pouch (e.g., 3M™ Steri-Lok™).

CAUTION: The catheter should be completely dry before sterilization.

Ethylene Oxide Sterilization Cycle Parameters

Preheat phase:	Starting Temperature 110 °F (43°C) min. Duration 30 minutes
Initial Vacuum:	6.0 inHgA (20.3 kPa) Rate: 3 minutes
Nitrogen Flush: 2 cycles	
Nitrogen Addition to:	28.0 ± 0.5 inHgA (94.8 ± 1.7 kPa)
Rate:	1.4 ± 0.5 inHgA/min. (4.7 ± 1.7 kPa/min.)
Evacuation:	6.0 ± 0.5 inHgA (20.3 ± 1.7 kPa)
Rate:	1.0 ± 0.5 inHgA/min. (3.4 ± 1.7 kPa)
Conditioning	
Humidification:	1.5 ± 0.5 inHgA (5.1 ± 1.7 kPa)
Steam Conditioning:	10 min.
Humidity Dwell:	30 ± 5 min. at 7.5 ± 0.5 inHgA (25.4 ± 1.7 kPa)
Relative Humidity:	15-70%
Ethylene Oxide Concentration:	500 ± 50 mg/L
Dwell Pressure:	16.5 ± 1.0 inHgA (55.8 ± 3.4 kPa)
Dwell Time:	2 hours
Temperature:	110-130 °F (43-54 °C)
Relative Humidity:	30-70% (35-44% nominal)
After Vacuum	
Vacuum:	6.0 ± 0.5 inHgA (20.3 ± 1.7 kPa)
Rate:	1.0 ± 0.5 inHgA/min. (3.4 ± 1.7 kPa)
Vacuum Hold:	10 min.
Gas Wash A:	4 cycles (minimum)
Release:	30.0 inHgA/min. (94.8 ± 1.7 kPa)
Rate:	1.4 ± 0.5 inHgA/min. (4.7 ± 1.7 kPa)
Vacuum	6.0 ± 0.5 inHgA (20.3 ± 1.7 kPa)
Rate:	1.0 ± 0.5 inHgA/min. (3.4 ± 1.7 kPa)
Release (Filtered Air):	28.0 ± 0.5 inHgA (94.8 ± 1.7 kPa)
Rate:	2.0 ± 0.5 inHgA/min. (6.6 ± 1.7 kPa)
Aeration (Hot Cell)	
Duration:	At least 8 hours
Temperature:	110 ± 10 °F (43 °C)

CAUTION: The Mikro-Tip transducer should not be used earlier than 5 days after sterilization.

- Connect the Millar pressure control unit to the monitor.
- Turn the pressure control unit function switch to STANDBY 0 and adjust the monitor to zero baseline.
- Turn the pressure control unit function switch to 100 mmHg and adjust the monitor sensitivity.
- Connect the extension cable to the pressure control unit.
- Connect the catheter to the extension cable.
- Turn the pressure control unit function switch to TRANSDUCER. Shield the sensor from light. Adjust the TRANSDUCER BALANCE CONTROL to zero baseline. LOCK the catheter balance.
- The catheter system is now ready for use.

Monitor ZERO-REFERENCE can be verified by setting the Millar pressure control unit selector switch to STANDBY 0 to reproduce the original zero baseline. Monitor zero baseline adjustment can be performed at this time if required. Monitor GAIN can then be verified by setting the selector switch to the 100 mmHg (13.3 kPa) position on the control unit. Monitor GAIN adjustments can be made at this time if required.

CAUTION: The “zero” output produced by placing the control unit function switch in the STANDBY 0 position is an electrical zero, not an atmospheric zero!

Operational Notes

CAUTION:	Use appropriate size introducer for catheter being used.
-----------------	--

CAUTION:	Use of an introducer smaller than 16 gauge can result in damage to the catheter on removal.
-----------------	---

CAUTION:	Consider use of systemic heparinization.
-----------------	--

Phonocardiogram Recording

Mikro-Tip catheters have pressure sensors with a sufficiently high frequency response to sense heart sounds. These transducers detect sounds simultaneously from many sources in a localized fashion. Heart sounds visible on the pressure waveform can be amplified and clearly displayed on a separate channel. Heart sounds less than the noise of the display system will display only that noise.

Handling Precautions for Mikro-Tip Catheters

	DO:	DO NOT:
Pressure Sensor	Clean immediately after use	Clean with stiff-bristled brush Clean with high pressure water jet
	Protect with dome when not in use	Tap the sensor against a rigid surface
	Disconnect during electrical defibrillation or electrosurgery to protect catheter sensor.	Apply excessive force to the sensor surface Expose to excessive pressure
Catheter	Clean immediately after use	Cut, crease, knot, fold, kink, or crush with forceps or clamps of any kind
Connector & Cables	Protect connectors from fluid	Immerse connectors in liquid

	DO:	DO NOT:
Cleaning	Keep catheter and sensor wet until cleaning	Expose to alcohol, cresols, phenols, mercury compounds, hypochlorites, acetone, peroxide, silicone chlorine, xylenes, trichloroethylene, or freon
	Clean thoroughly with approved enzymatic cleanser immediately after use	Use ultrasonic cleaner. Immerse electrical connector
Sterilizing	Dry catheter before sterilizing	Autoclave, irradiate (gamma/e-beam), plasma, peroxide or formaldehyde vapor solutions
	Remove plastic dome from catheter	Use Sporox or Cidex PA solutions

Troubleshooting and Corrective Maintenance

Problem	Probable Cause	Corrective Action
Excessive Drift	Deposit of foreign material on the diaphragm of the pressure sensor.	Follow Cleaning Instructions. If problem persists, contact Millar.
Transducer will not balance (zero)	Moisture in the connector, damage to wires in the catheter, or fractured strain gauge within pressure sensor	Follow Operating Instructions or substitute a transducer known to be operating properly into the recording system.

Cleaning

Approved Cleaners and Disinfectants

Type	Trade Name	Manufacturer	Active Ingredient.	Soak Time/Temperature
Enzymatic Detergent	Enzol® (in UK: Cidezyme®)	Advanced Sterilization Products (J&J)	Propylene Glycol	15 minutes / room temperature
	Endozime®	Ruhoff Corporation	Propylene Glycol	15 minutes / room temperature
	Terg-A-Zyme®	Alconox	Sodium Dodecylbenzene	15 minutes / room temperature
High-level Disinfectant	Cidex Activated Dialdehyde Solution	Advanced Sterilization Products (J&J)	Glutaraldehyde	1-2 hours / 25 °C (77°F)
High-level Disinfectant	Cidex® OPA	Advanced Sterilization Products (J&J)	Ortho-phthalaldehyde	16-30 minutes / 20 °C (68°F)
	MetriCide®	Metrex	Glutaraldehyde	1-2 hours / 25 °C (77°F)

DO NOT USE:

- Glutaraldehyde solutions containing surfactants (e.g., Cidex 7 or Cidex Plus 28 Day)
- Solutions containing hydrogen peroxide (e.g. Sporox)
- Cidex PA solution

Water Resistant Connector Caps

Each catheter has water-resistant caps to protect electrical pins and circuitry. Place caps over the open end of the connectors before cleaning and disinfecting. Remove caps prior to sterilization. Save and reuse these caps each time the catheter is cleaned and disinfected.

Cleaning Procedure

CAUTION:	DO NOT submerge the connectors. This will damage the catheter and void its warranty! Wipe with cleaner and gauze.
-----------------	---

CAUTION:	DO NOT pull on the sensor tip end of the catheter while cleaning, wiping, or drying the catheter.
-----------------	---

CAUTION:	Use only the listed cleaners for the times/temperatures indicated.
-----------------	--

CAUTION:	Delays in rinsing greatly reduce cleaning effectiveness!
-----------------	--

1. Wipe catheter with wetted gauze immediately after use.
2. Submerge only the distal contaminated portion of the catheter in room-temperature water (DO NOT use hot water) up to the connector's strain relief.
3. Wipe the proximal outer surface of the catheter (including connector) with soft gauze.
4. Prepare cleaning solution. Place the distal portion of the catheter in the cleaning solution.
5. Wet soft surgical gauze with the cleaning solution. Wipe the outer surface of the catheter with gauze.
6. Soak distal portion of the catheter in a cleaning solution for the time specified, and then remove.
7. Gently wipe the catheter and sensor clean with a soft, wet gauze or tissue.
8. Immediately rinse the catheter and sensor(s) at least three times with sterile, pyrogen-free water. Do not reuse the water from each rinse, as it will contain residuals from the cleaner.
9. Dry the outside of the catheter with soft gauze.
10. Package for sterilization.
11. Failure to clean and sterilize according to directions may void catheter warranty.

Disinfection

1. The catheter must be cleaned, rinsed and dried prior to disinfection. Soil, debris, proteins, and water can interfere with the effectiveness of the following procedure, posing a risk to the research subject and the user. Note that some disinfectants have a limited usable life after activation or opening the container. Failure to heed such warnings can inhibit the effectiveness of the disinfection process.
2. Prepare the disinfectant according to the manufacturer's instructions.
3. Submerge the catheter into the disinfectant up to the connector strain. Do not submerge the connector as it will damage the transducer and void the warranty.
4. The disinfectant must be in contact with all surfaces that need to be disinfected.
5. Soak the transducer in the disinfectant at the temperature and time intervals listed.

Rinsing after Disinfection

1. Rinse the transducer catheter by submerging all exterior disinfected surfaces in sterile pyrogen-free water. The volume of the water should be at least two gallons (7.6 liters) and the soak time should be at least one minute.
2. At least three separate rinses are required. Do not reuse any of the water used for rinsing since it will be contaminated with the disinfectant.