

World Headquarters

Millar, Inc.
6001-A Gulf Freeway
Houston, Texas 77023 USA
Phone: 832-667-7000 or 800-669-2343 (in the USA)
Fax: 713-714-8497
Email: info@millar.com
Web site: millar.com

Millar Worldwide Distribution

Millar, Inc. has a network of Authorized Distributors in most countries around the world. For information on the Millar distributor in your country, please contact the Millar Customer Service Department at our headquarters in Houston, Texas.



Making the
improbable possible.

Mikro-Tip® Catheter Pressure Transducer

Animal Use Only

Instructions for Use

© 2007, 2013 Millar, Inc. All rights reserved.
Millar and Mikro-Tip are registered trademarks of Millar, Inc.
Products and company names used are the trademarks or trade names of their respective companies.
Models referred to herein are protected by USA and International patents.







M.I. P/N: 004-2129 Rev. G

Table of Contents

RECOMMENDED ACCESSORIES	1
DEVICE DESCRIPTION.....	1
INTENDED USE/INDICATIONS	2
WARNINGS.....	2
PRECAUTIONS	2
MAINTAINING DEVICE EFFECTIVENESS.....	2
STORAGE	2
PLASTIC DOME FITTING.....	2
ROUTINE INSPECTION AND TESTING	2
CATHETER.....	2
PRESSURE SENSOR(S)	3
CONNECTOR(S) AND CABLE(S).....	3
TRANSDUCER VERIFICATION AND SETUP	3
OPERATING INSTRUCTIONS	3
OPERATIONAL NOTES	3
HIGH-SPEED INJECTION CATHETERS.....	4
SPECIAL FLUSHING INSTRUCTIONS PRIOR TO INJECTION	4
CATHETERS FOR USE WITH GUIDE WIRES.....	4
PHONOCARDIOGRAM RECORDING	4
HANDLING PRECAUTIONS FOR MIKRO-TIP CATHETERS.....	5
TROUBLESHOOTING AND CORRECTIVE MAINTENANCE	5
CLEANING.....	5
APPROVED CLEANERS AND DISINFECTANTS.....	5
WATER RESISTANT CONNECTOR CAPS.....	6
CLEANING PROCEDURE.....	6
DISINFECTION	7
RINSING AFTER DISINFECTION	7
METHOD OF STERILIZATION FOR CATHETERS AND EXTENSION CABLES (OPTIONAL).....	7
ETHYLENE OXIDE STERILIZATION CYCLE PARAMETERS	8
SENSOR SPECIFICATIONS	9
SCHEMATICS.....	10
FIGURES.....	11
SERVICE PROVISION.....	13
MILLAR LIMITED WARRANTY.....	13

Recommended Accessories

M.I. P/N: 851-5918, Model TC-510 Control Unit, No patient isolation
M.I. P/N: 880-0129, Model PCU-2000 Control Unit with Patient Isolation
M.I. P/N: 850-1118, Model TEC-5C Extension Cable
M.I. P/N: 850-1108, Model TEC-10C Extension Cable
M.I. P/N: 850-1308, Model TEC-10D Extension Cable
M.I. P/N: 850-5089, Model PEC-10C Extension Cable to PCU-2000
M.I. P/N: 850-5090, PEC-10D Extension Cable to PCU-2000
Monitor Input Cables as appropriate for monitor.
All accessories sold separately.

Definition of Symbols	
	Attention, consult accompanying documents
	Date of Manufacture
REF	Catalog Number
SN	Serial Number
	Batch Code
	Use By Date
	Electrostatic Sensitive Device
	EU Declaration of Conformity

Device Description

Mikro-Tip catheters consist of an ultra-miniature pressure sensor(s) at the distal end of a catheter, as shown in Figure 1, with an electrical connector(s) at the proximal end. The pressure sensor produces an electrical output signal, which varies in direct proportion to the magnitude of sensed pressure.

Mikro-Tip catheters are intended for multiple uses. Experience has proven that the instruments are safe and effective for extended service if proper handling, cleaning, and sterilization procedures are followed.

Immediately upon receipt of the catheter, and prior to its initial cleaning, sterilization, and use, the customer should verify that the catheter is operational.

Flexible extension cables are available for connection between the pressure connector and the pressure control unit. These flexible cables facilitate maneuvering the catheter during recording. They may be sterilized to permit connection of the transducer to a Millar control unit outside the sterile field.

Service Provision

Consult web site below for service information:

millar.com

Millar Limited Warranty

Millar, Inc. (Millar) warrants that at the time of sale to the original purchaser, the device was free from defects in both materials and workmanship. For a period of 365 days (1-year) from the date of original shipment to the original purchaser, Millar will, at no charge and at its option, either repair or replace any Mikro-Tip transducer found to have been shipped with defects in either materials or workmanship. Our warranty does not cover damage to the product from alterations, misuse, abuse, negligence, or accident. The SPR-524 is warranted for a period of 30 days from the date of original shipment to the original purchaser. The SPR-524 is non-repairable.

Millar hereby excludes all warranties not herein stated, whether express or implied by operation of law or course of dealing or trade usage or otherwise, including but not limited to any implied warranties of fitness or merchantability.

Since handling, storage, cleaning and sterilization of the product, as well as factors relating to patient diagnosis, treatment, catheterization procedures, and other matters beyond Millar's control, directly affect the product and the results obtained from its use, Millar shall not be liable for any incidental or consequential loss, damage, or expense arising directly or indirectly from the use of this product.

The user shall determine suitability for use of these medical devices for any surgical or clinical procedure. Therefore, the user accepts these devices subject to all the terms hereof. Further, Millar makes no warranty regarding device efficacy after three (3) years from the date of manufacture.

Intended Use/Indications

The use of Mikro-Tip catheter is indicated when physiological pressures are to be measured.

For cardiovascular applications, Mikro-Tip catheters may be introduced into the cardiovascular system percutaneously or through the wall of a surgically exposed artery or vein.

With the aid of fluoroscopy or echocardiography, the transducer may be advanced from the introduction site to the desired location.

This product is designed for use by professionals with appropriate education and training in life science and medical research applications.

Warnings

- Mikro-Tip transducer catheters are shipped with a plastic or foam dome fitting over the pressure sensor. The dome should be in place during handling.
- Do not allow any body fluids to collect under protective covering on catheter connector; otherwise, sterilization cannot be assured.

Precautions

Use of Mikro-Tip catheters should be restricted to specialists who are familiar with, and have been trained to perform, the catheterization procedures for which the device is intended.

- Inspect the Mikro-Tip catheter for damage (cracking, kinks, etc.) prior to each use.
- Clean the Mikro-Tip catheter immediately after each use (see Cleaning).
- Store Mikro-Tip catheters in a dark, cool, dry place.
- Do not touch the sensor area with sharp objects. Do not make sharp bends in the catheter.
- Refrain from applying direct pressure to the sensor area with instruments such as forceps or tweezers.
- When handling the catheter with either fingertips or surgical instruments, always grip several millimeters (5-10 mm) proximal to the sensor area. The sensor area contains very fragile wires which may be damaged or broken if the catheter is gripped too close to the sensor.
- Avoid electrostatic discharge to the Mikro-Tip sensor. Do not touch the sensor element while the catheter is disconnected from monitoring equipment.

Maintaining Device Effectiveness

Storage

Store the catheter in the plastic tray provided. Make sure the catheter has a plastic or foam dome fitting over each pressure sensor.

Plastic Dome Fitting

All catheters are shipped with a protective tubing(s) and/or plastic dome fitting over the pressure sensor(s) to protect the sensor from damage. Plastic Domes **ARE NOT** interchangeable.

When using the plastic dome fitting, the tip of the pressure sensor should be positioned inside the plastic dome fitting as shown in Figure 2.

Routine Inspection and Testing

CAUTION: If damage is found during inspection, DO NOT use the catheter. Contact Millar or authorized distributor.

Catheter

Inspect each catheter thoroughly before and after each use. Carefully examine the catheter for defects.

Pressure Sensor(s)

Examine the pressure sensor active surface (diaphragm) for blood or materials not removed by cleaning. A dirty sensor may cause short-term baseline drift. Follow cleaning directions in this IFU.

Connector(s) and Cable(s)

The connector(s) should be routinely inspected for corrosion or bad contacts. Liquid entering the connector(s) can cause electrical hazard, erratic operation and components corrosion.

Transducer Verification and Setup

CAUTION: DO NOT handle or squeeze the pressure transducers during catheter manipulation!

Each transducer is calibrated for a standardized sensitivity of **5 μ V/V/mmHg (37.6 μ V/V/kPa)**.

To verify system outputs, apply a reference pressure signal to adjust sensitivity or to specific monitor requirement. Use a mercury manometer or pressure reference device, as shown in Figure 3a or 3b.

Apply a known pressure to the Millar catheter and verify the signal at the monitor.

Follow the instructions for the Millar pressure control unit being used. Set up the mercury manometer as shown in 3a or 3b and compare the 100 mmHg (13.3 kPa) output produced using the mercury manometer with the electrical 100 mmHg (13.3 kPa) produced by the control unit.

Reading errors at or near the 0 mmHg (0kPa) manometer indication can be minimized by offsetting the manometer zero indication to 20 mmHg (26.6 kPa) and using the 100 mmHg (133 kPa) increments from the 20-120 mmHg (26.6 – 160 kPa) pressure indication rather than the 0-100 mmHg (0-133 kPa) pressure indication.

Errors due to inconsistent meniscus shape between consecutive readings can be minimized by adjusting the pressure at each reading to maintain a consistent curve at the top of the meniscus. These errors may be avoided by using an electronic pressure meter as shown in Figure 3b.

Operating Instructions

When Using a Millar Pressure Control Unit (see Control Unit's IFU)

1. Soak the sensor in room-temperature sterile water or sterile saline for 30 minutes prior to use to minimize drift.
2. Connect the Millar pressure control unit to the monitor.
3. Turn the pressure control unit function switch to STANDBY 0 and adjust the monitor to zero baseline.
4. Turn the pressure control unit function switch to 100 mmHg and adjust the monitor sensitivity.
5. Connect the extension cable to the pressure control unit.
6. Connect the catheter to the extension cable.
7. Turn the pressure control unit function switch to TRANSDUCER. Shield the sensor from light. Adjust the TRANSDUCER BALANCE CONTROL to zero baseline. LOCK the catheter balance.
8. The catheter system is now ready for use.

Monitor ZERO-REFERENCE can be verified by setting the Millar pressure control unit selector switch to STANDBY 0 to reproduce the original zero baseline. Monitor zero baseline adjustment can be performed at this time if required. Monitor GAIN can then be verified by setting the selector switch to the 100 mmHg (13.3 kPa) position on the control unit. Monitor GAIN adjustments can be made at this time if required.

CAUTION: The "zero" output produced by placing the control unit function switch in the STANDBY 0 position is an electrical zero, not an atmospheric zero!

Operational Notes

CAUTION: Use appropriate size introducer for catheter being used.

CAUTION: Consider use of systemic heparinization.

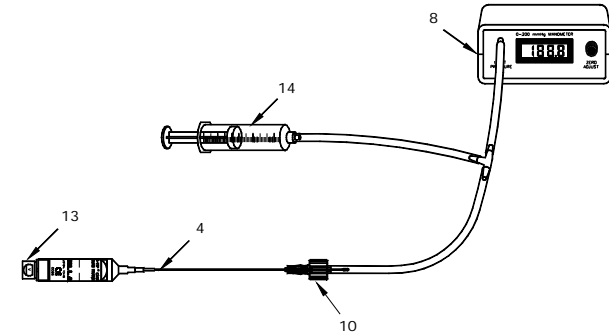

Figure 3b

Figure Legend

- | | |
|------------------------------|----------------------------------|
| 1. Pressure Sensing Area | 7. Luer Fitting |
| 2. Wires to Connector | 8. Mercury Manometer |
| 3. Vent to Connector | 9. Tee Fitting |
| 4. Catheter | 10. Plastic Dome |
| 5. Silicone Rubber Diaphragm | 11. Pressure Transducer Catheter |
| 6. Pressure Sensor | 12. To Recorder |

Figures

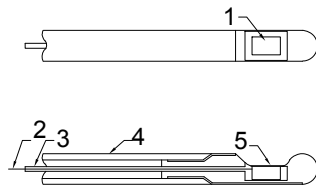

Figure 1

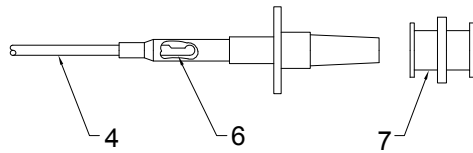

Figure 2

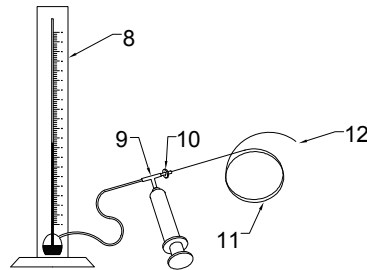

Figure 3a

High-speed Injection Catheters

Use catheters only for injection of contrast media and short-term pressure measurements.

For Renografin 76, 7F single sensor pressure transducer rate is typically 10-15 ml/sec at 1000 psi (6895 kPa) and 8F is 20-25 ml/sec. 8F dual pressure sensor transducer rate is typically 10 ml/sec at 1200 psi (8274 kPa). Priming volume is approximately 1.6 ml (7F) and 2.4 ml (8F).

Special Flushing Instructions Prior to Injection

A saline drip will not adequately irrigate the tip of high-speed injection side-hole catheters with a pigtail tip or extension. To prevent air emboli formation:

1. Fill the lumen and tip or extension with saline before introducing the catheter. Cover the side holes during filling to ensure that the tip or extension is filled.
2. Keep the catheter lumen filled with flushing solution or contrast medium while in use.
3. Flush the catheter with 10-15 ml saline every two minutes, or as needed.

Catheters for Use with Guide Wires

All guide wire catheters are designed to be inserted and advanced over a guide wire. The distal pigtail extension may fold and buckle if the catheter is advanced without the guide wire in position. Never advance the guide wire against resistance.

CAUTION: Verify maximum guide wire outside diameter before use. Do not handle or squeeze the pressure sensors when inserting the guide wire.

A "J" guide wire should not be inserted or advanced from the hub end of a catheter with side openings for high-speed injection. If a straight guide wire is inserted or advanced from the hub end of one of these catheters, care should be taken to ensure that the guide wire does not exit through the lumen side openings. Remove guide wire immediately after use.

Flush catheter immediately after use. During flushing, intermittently occlude lumen side openings to ensure complete flushing of the distal catheter extension.

Phonocardiogram Recording

Mikro-Tip catheters have pressure sensors with a sufficiently high frequency response to sense heart sounds. These transducers detect sounds simultaneously from many sources in a localized fashion. Heart sounds visible on the pressure waveform can be amplified and clearly displayed on a separate channel. Heart sounds less than the noise of the display system will display only that noise.

Handling Precautions for Mikro-Tip Catheters

	DO:	DO NOT:
Pressure Sensor	Clean immediately after use	Clean with stiff-bristled brush
	Protect with dome when not in use	Clean with high pressure water jet
	Disconnect during electrical defibrillation or electrosurgery	Tap the sensor against a rigid surface
		Apply excessive force to the sensor surface
		Expose to excessive pressure
Catheter & Pigtail	Clean immediately after use	Cut, crease, knot, fold, kink, or crush with forceps or clamps of any kind
Connector & Cables	Protect connectors from fluid	Immerse connectors in liquid
Lumen	Clean immediately after use	Over pressurize
	Flush during use	Use Teflon-coated guide wires.
		Use cleaning wires or guide wires on models not designed for guide wires
Cleaning	Keep catheter, lumen, and sensor wet until cleaning	Expose to alcohol, cresols, phenols, mercury compounds, hypochlorites, acetone, peroxide, silicone chlorine, xylenes, trichloroethylene, or freon
	Clean thoroughly with approved enzymatic cleanser immediately after use	Use ultrasonic cleaner.
		Immerse electrical connector
Sterilizing	Dry catheter and lumen before sterilizing	Autoclave, irradiate (gamma/e-beam), plasma, peroxide or formaldehyde vapor solutions
	Remove plastic dome from catheter	Use Sporox or Cidex PA solutions

Troubleshooting and Corrective Maintenance

Problem	Probable Cause	Corrective Action
Excessive Drift	Deposit of foreign material on the diaphragm of the pressure sensor.	Follow Cleaning Instructions. If problem persists, contact Millar.
Transducer will not balance (zero)	Moisture in the connector, damage to wires in the catheter, or fractured strain gauge within pressure sensor	Follow Operating Instructions or substitute a transducer known to be operating properly into the recording system.

Cleaning

Approved Cleaners and Disinfectants

Type	Trade Name	Manufacturer	Active Ingredient.	Soak Time/Temperature
Enzymatic Detergent	Enzol® (in UK: Cidezyme®)	Advanced Sterilization Products (J&J)	Propylene Glycol	15 minutes / room temperature
	Endozime®	Ruhoff Corporation	Propylene Glycol	15 minutes / room temperature
	Terg-A-Zyme®	Alconox	Sodium Dodecylbenzene	15 minutes / room temperature
High-level Disinfectant	Cidex Activated Dialdehyde Solution	Advanced Sterilization Products (J&J)	Glutaraldehyde	1-2 hours / 25 °C (77°F)
High-level Disinfectant	Cidex® OPA	Advanced Sterilization Products (J&J)	Ortho-phthalaldehyde	16-30 minutes / 20 °C (68°F)
	MetriCide®	Metrex	Glutaraldehyde	1-2 hours / 25 °C (77°F)

Schematics

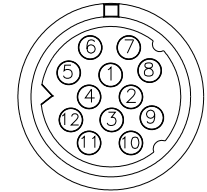
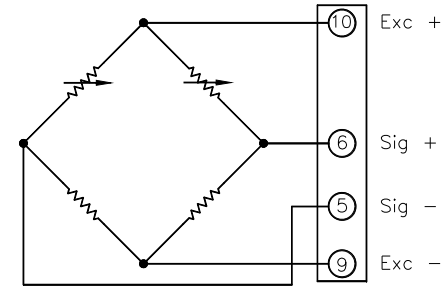

Sensor & Viking Connector

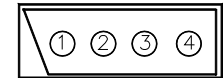
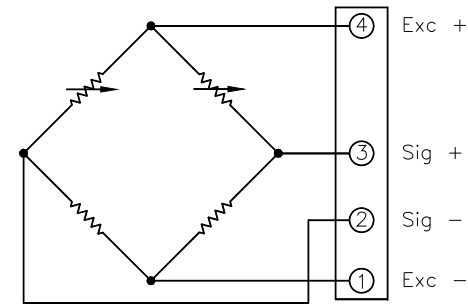

Sensor & Low Profile Connector

Sensor Specifications

	2F Catheter	≥3F Catheter
Type of Sensor	Diffused Semiconductor, piezoresistive	
Pressure Range	-50 to + 300 mmHg (-6.7 to 40 kPa)	
Overpressure	+4000 mmHg (+530 kPa), -760 mmHg (100 kPa)	
Rated Excitation*	2.5-7.5 V _{DC} or V _{AC} rms	
Sensitivity	5 μV/V/mmHg, nominal (37.6 μV/V/kPa)	
Temperature Error Band at Zero Pressure	±3 mmHg (± 0.4 kPa) BSL, 23 - 38 °C	±1.5 mmHg (±0.2 kPa), BSL, room temperature to body temperature [3 mmHg (0.4 kPa) maximum shift, approximately 23-38 °C]
Linearity and Hysteresis	±1%, BSL of full scale	±0.5%, BSL of full scale
Drift**	<6 mmHg (0.8 kPa) in 12 hours	
Natural Frequency	≥10 kHz	
Bridge Resistance	1000 ohms, nominal	
Reference Pressure	Atmosphere	
Electrical Leakage	< 10 μA at 180 V _{DC} 10 μA at 120 V _{AC}	< 10 μA at 600 V _{DC} 10 μA at 120 V _{AC}
Zero Offset	< ±50 mmHg (± 6.7 kPa)	

* Performance specifications are for 5 V_{DC}. Transient voltages up to 20 volts will not damage the transducer.

** Based on 30 minute presoak.

DO NOT USE:

- Glutaraldehyde solutions containing surfactants (e.g., Cidex 7 or Cidex Plus 28 Day)
- Solutions containing hydrogen peroxide (e.g. Sporox)
- Cidex PA solution

Water Resistant Connector Caps

Each catheter has water-resistant caps to protect electrical pins and circuitry. Place caps over the open end of the connectors before cleaning and disinfecting. Remove caps prior to sterilization. Save and reuse these caps each time the catheter is cleaned and disinfected.

Cleaning Procedure

CAUTION:	DO NOT submerge the wye junction or connectors. This will damage the catheter and void its warranty! Wipe with cleaner and gauze.
-----------------	---

CAUTION:	Use only the listed cleaners for the times/temperatures indicated.
-----------------	--

CAUTION:	Delays in rinsing greatly reduce cleaning effectiveness!
-----------------	--

1. Wipe catheter with wetted gauze and flush catheter lumen with water immediately after use to remove bulk contaminants. During flushing, intermittently occlude lumen side openings to ensure complete flushing of the catheter tip.
2. Submerge only the distal contaminated portion of the catheter in room-temperature water (DO NOT use hot water) up to the wye junction, or the connector's strain relief. If applicable, flush the lumen with water until the effluent is clear. Wipe the proximal outer surface of the catheter (including wye junction, and connector(s)) with soft gauze.
3. Clean the interior of the lumen hub with a wet Q-tip.
4. Prepare cleaning solution. Place the distal portion of the catheter in the cleaning solution.
5. If applicable, use a 15 cc syringe to flush the lumen with cleaning solution until no air bubbles are seen coming from the lumen. Leave the syringe attached so that the cleaner will continue to fill the lumen.
6. Wet soft surgical gauze with the cleaning solution. Wipe the outer surface of the catheter with gauze.
7. Soak distal portion of the catheter in a cleaning solution for the time specified, and then remove.
8. If applicable, remove syringe, clean the interior of the lumen hub with Q-tips soaked in cleaning solution. Drain the cleaner from the lumen of the catheter. Gently wipe the catheter and sensor clean with a soft, wet gauze or tissue.
9. Immediately rinse the catheter and sensor(s) at least three times with sterile, pyrogen-free water. Do not reuse the water from each rinse, as it will contain residuals from the cleaner.
10. If applicable, immerse catheter lumen distal openings in sterile, pyrogen-free water and aspirate at least 150 cc through the lumen. Flush lumen with sterile, pyrogen-free water at least three times.
11. Dry the outside of the catheter with soft gauze. Dry the lumen with at least fifteen 60-cc syringes of air, filtered air (900 cc), or carbon dioxide.
12. Package for sterilization. It is crucial that the lumen be dried completely.
13. Failure to clean and sterilize according to directions may void catheter warranty.

Disinfection

1. The catheter must be cleaned, rinsed and dried prior to disinfection. Soil, debris, proteins, and water can interfere with the effectiveness of the following procedure, posing a risk to the patient and the user. Note that some disinfectants have a limited usable life after activation or opening the container. Failure to heed such warnings can inhibit the effectiveness of the disinfection process.
2. Prepare the disinfectant according to the manufacturer's instructions.
3. Fill a 10cc syringe with the disinfectant.
4. Connect the syringe to the lumen hub of the catheter.
5. Submerge all of the catheter's lumen vents in a bath of the disinfectant. Submerge the catheter into the disinfectant up to the junction (dual-sensor or lumen models) or the connector strain relief (single-sensor/no-lumen models). Do not submerge the junction or the connector as it will damage the transducer and void the warranty.
6. Forcefully inject the contents of the syringe into the lumen and observe the disinfectant leaving the vents. If the disinfectant leaving the vents is not bubble-free, a larger syringe will be needed. Make sure that there are no bubbles on the surface of the catheter. The disinfectant must be in contact with all surfaces that need to be disinfected.
7. With the syringe still connected and the lumen vents still submerged, forcefully draw 3cc of disinfectant back into the syringe.
8. Force the disinfectant back through the lumen and observe the disinfectant leaving the vents to confirm that it is bubble-free.
9. Perform at least three cycles of inject/draw/inject. It is important to remove all bubbles from the lumen to ensure that all surfaces of the lumen are disinfected. Leave the syringe connected to the lumen hub so that the disinfectant will continue to completely fill the lumen.
10. Soak the transducer in the disinfectant at the temperature and time intervals listed.

Rinsing after Disinfection

1. Drain the disinfectant from the lumen of the catheter.
2. Rinse the device by submerging all exterior disinfected surfaces in sterile pyrogen-free water. The volume of the water should be at least two gallons (7.6 liters) and the soak time should be at least one minute.
3. At least three separate rinses are required. Do not reuse any of the water used for rinsing since it will be contaminated with the disinfectant.
4. During each rinse, inject 120cc of sterile pyrogen-free water through the lumen.

Method of Sterilization for Catheters and Extension Cables (Optional)

CAUTION: DO NOT sterilize by autoclaving, radiation (gamma or e-beam), plasma, peroxide or formaldehyde vapor solutions.

Catheters must be completely cleaned and dried before sterilization. Aerate at room temperature or in a heated aeration cabinet. (max. 145 °F, 63 °C) Catheters may be sterilized in the white plastic shipping tray. The foam dome and connector caps must be removed and placed alongside the catheter inside the pouch during sterilization. The caps should be saved and reused each time the catheter is cleaned.

The tray, with lid, should be placed in a breathable polyethylene pouch (e.g., 3M™ Steri-Lok™).

CAUTION: The catheter should be completely dry before sterilization.

Ethylene Oxide Sterilization Cycle Parameters

Preheat phase:	Starting Temperature 110 °F (43°C) min. Duration 30 minutes
Initial Vacuum:	6.0 inHgA (20.3 kPa) Rate: 3 minutes
Nitrogen Flush: 2 cycles	
Nitrogen Addition to:	28.0 ± 0.5 inHgA (94.8 ± 1.7 kPa)
Rate:	1.4 ± 0.5 inHgA/min. (4.7 ± 1.7 kPa/min.)
Evacuation:	6.0 ± 0.5 inHgA (20.3 ± 1.7 kPa)
Rate:	1.0 ± 0.5 inHgA/min. (3.4 ± 1.7 kPa)
Conditioning	
Humidification:	1.5 ± 0.5 inHgA (5.1 ± 1.7 kPa)
Steam Conditioning:	10 min.
Humidity Dwell:	30 ± 5 min. at 7.5 ± 0.5 inHgA (25.4 ± 1.7 kPa)
Relative Humidity:	15-70%
Ethylene Oxide Concentration:	500 ± 50 mg/L
Dwell Pressure:	16.5 ± 1.0 inHgA (55.8 ± 3.4 kPa)
Dwell Time:	2 hours
Temperature:	110-130 °F (43-54 °C)
Relative Humidity:	30-70% (35-44% nominal)
After Vacuum	
Vacuum:	6.0 ± 0.5 inHgA (20.3 ± 1.7 kPa)
Rate:	1.0 ± 0.5 inHgA/min. (3.4 ± 1.7 kPa)
Vacuum Hold:	10 min.
Gas Wash A:	4 cycles (minimum)
Release:	30.0 inHgA/min. (94.8 ± 1.7 kPa)
Rate:	1.4 ± 0.5 inHgA/min. (4.7 ± 1.7 kPa)
Vacuum	6.0 ± 0.5 inHgA (20.3 ± 1.7 kPa)
Rate:	1.0 ± 0.5 inHgA/min. (3.4 ± 1.7 kPa)
Release (Filtered Air):	28.0 ± 0.5 inHgA (94.8 ± 1.7 kPa)
Rate:	2.0 ± 0.5 inHgA/min. (6.6 ± 1.7 kPa)
Aeration (Hot Cell)	
Duration:	At least 8 hours
Temperature:	110 ± 10 °F (43 °C)

CAUTION: The Mikro-Tip transducer should not be used earlier than 5 days after sterilization.